



383 Kent Street, Sydney

Operational Waste Management Plan

Prepared by Foresight Environmental

e. info@foresightenvironmental.com

w. www.foresightenvironmental.com

This report is based on information provided by **Charter Hall Holdings Pty Ltd** coupled with Foresight Environmental's knowledge of waste generated within the commercial sector. To that extent this report relies on the accuracy of the information provided to the consultant. It has been compiled by Foresight Environmental on behalf of **Charter Hall Holdings Pty Ltd.**

This report is not a substitute for legal advice on the relevant environmental related legislation, which applies to businesses, contractors, or other bodies. Accordingly, Foresight Environmental will not be liable for any loss or damage that may arise out of this project, other than loss or damage caused as a direct result of Foresight Environmental's negligence.

The contents of this report should be always treated as confidential, unless permission from **Charter Hall Holdings Pty Ltd** is received.

The contents of this document may not be referenced or used in any way by parties other than **Charter Hall Holdings Pty Ltd** without the written permission of Foresight Environmental.

Document Information		
Client	Charter Hall Holdings Pty Ltd	
Prepared by	Foresight Environmental	
Document name	383 Kent Street Operational Waste Management Plan	
Author	Sophie Rutherford	
Reviewed	Scott Ebsary	
Revision	Revision Date	Details/comments
1	24 November 2022	Preliminary feedback provided
2	24 February 2023	Draft report capturing Touchstone comments from December
3	21 March 2023	Updates added from word doc sent by Touchstone on 20/03/23
4	23 May 2023	Updates added from word doc sent by Tracey Hoven (Touchstone) on 17/05/2023
5	29 June 2023	Updates added from email sent by Sharan Saini on 23/06/2023
6	11 July 2023	Updated GFAs as per email from Sharan Saini 11/07/2023
7	8 December 2023	Updated general description, updated plans (1/12/23) added, updated GFAs

Table of Contents

1. EXECUTIVE SUMMARY	4
2. OVERVIEW OF DEVELOPMENT	4
2.1 SITE DESCRIPTION	5
3. OPERATIONAL USAGE	6
4. WASTE GENERATION ESTIMATE	7
4.1 COMMERCIAL WASTE	8
4.2 RETAIL WASTE	8
4.3 TOTAL WASTE	ERROR! BOOKMARK NOT DEFINED.
5. WASTE MANAGEMENT SYSTEMS	9
6. WASTE MANAGEMENT AREAS	10
6.1 CENTRAL WASTE STORAGE AREA - B1	10
6.2 INTERNAL MOVEMENT OF WASTE	ERROR! BOOKMARK NOT DEFINED.
6.3 WASTE ROOM AMENITY	11
6.4 SIGNAGE	12
7. ONSITE MANAGEMENT PROTOCOLS	13
7.1 TENANT FLOORS	13
7.2 ADDITIONAL MATERIAL STREAMS	15
7.3 CLEANER'S PROCESS	16
7.4 RETAIL BACK OF HOUSE	16
7.5 RETAIL INTERNAL MOVEMENT OF WASTE	18
8. COLLECTION	21
8.1 COLLECTION POINTS	21
8.2 COLLECTION VEHICLES	22
9. REPORTING	23
9.1 OSAT ONSITE SCALES	24
10. CONCLUSION	25
APPENDIX 2 - OSAT ONSITE SCALES	26

1. Executive Summary

This Operational Waste Management Plan (OWMP) has been prepared by Foresight Environmental in support of a Planning Proposal to amend the *Sydney Local Environment Plan 2012* (Sydney LEP). This report has been prepared on behalf of Charter Hall Holdings Pty Ltd (Charter Hall) (the Proponent) and it relates to a single development lot identified as Lot 1 in DP 778342 or 383 Kent Street, Sydney (the site), in accordance with the following guidelines:

- City of Sydney Guidelines for Waste Management in New Developments 2018
- City of Sydney Development Control Plan 2012
- Better Buildings Partnership Operational Waste Guidelines
- Greenstar Design and As Built v1.3

The plan details how 383 Kent Street, Sydney, will manage the waste and recycling generated during the ongoing operation of the development.

2. Overview of Development

The purpose of this Planning Proposal is to amend the site's maximum Height of Building development standard and maximum Floor Space Ratio (FSR) development standard to unlock additional floor space to be used exclusively for employment generating land uses, consistent with the vision and intent of the *Central Sydney Planning Strategy* (CSPS) for tower cluster sites. This Planning Proposal will also seek to facilitate significant public benefits through additional site activation by way of a new pedestrian through-site link, shared loading dock facility and delivering on sustainable initiatives to contribute to the City of Sydney's vision to achieve net zero energy buildings.

The proposed Sydney LEP amendment is part of the broader redevelopment plan for the site to demolish the existing structure on the site (including the existing 10 storey car park) and construct a new 42 storey commercial office tower with a total maximum FSR of 20:1 (circa 73,000m² GFA).

The reference scheme supporting the Planning Proposal and site specific DCP can be described as follows:

Demolition of the existing building, including removal of the over 800 capacity public car park.

Construction of the following:

- New 42-storey office tower comprising a total FSR of 20:1, up to a height of RL 189.80 (approximately 170m above Kent Street and 180m above Sussex Street).
 - New premium-grade commercial floorspace with an approximate GFA of circa 73,000 m².
 - New through-site link connecting Kent and Sussex Streets, including public art activation.
 - New ground floor activation opportunities, including approximate retail GFA of circa 640 m².
 - 2 levels of basement, comprising:
 - Basement Level 1 facilitating 72 car parking spaces; and
 - Sussex Street ground level shared loading dock facility including SRV and MRV short term stay bays to service retail tenancies within buildings along Kent Street (located between Market Street and King Street).
- New end of trip facilities below the Kent Street ground level.

2.1 Site Description

Figure 1: Site location in context

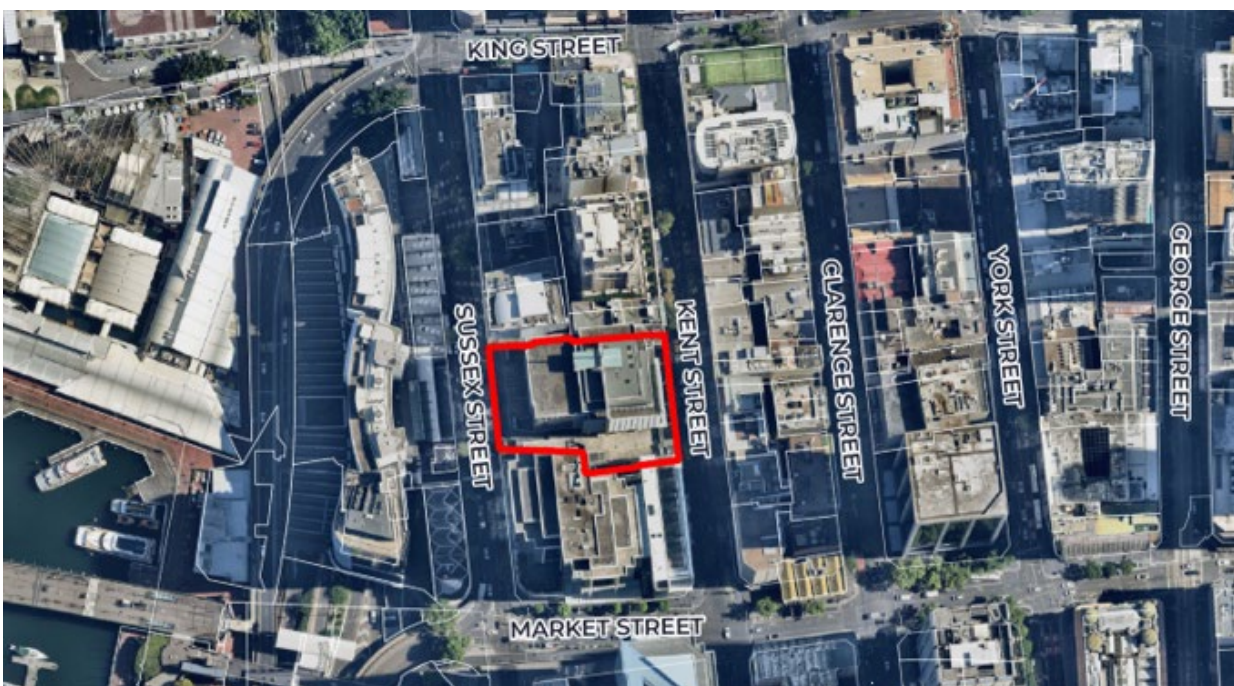

3. Operational Usage

The following tables show the development area profile Gross Floor Area (GLA), and the Net Lettable Area (NLA) breakdown that has been used to estimate a waste profile for both the commercial and retail areas. Note: these areas are based on approximate information provided at the time of writing and are subject to change through the respective future DA processes for each.

For the purposes of estimating a waste profile for the development, the NLA of the waste generating components is used in conjunction with Foresight Environmental’s extensive database of actual operational data from similar developments/assets.

The usage breakdown by area is as follows:

Table 1 - Proposed development area profile: GFA

Area	GFA	Usage/Assumptions
Commercial	72,300m ²	Standard high-end office
Retail	700m ²	All food & beverage
Total GFA	73,000 m²	Combined Asset

Table 2 - Area breakdown by waste generating areas: NLA

Area	NLA (m ²)	Usage/Assumptions
Commercial	65,000	Standard high-end office
Retail	680	All food & beverage
Total NLA	65,680	Combined Asset

4. Waste Generation Estimate

Based on the information provided regarding the proposed development and the intended uses of all workspaces and food service areas, a waste estimate has been derived using Foresight Environmental's extensive database of ongoing operational waste data from similar developments.¹ Based on the estimated waste profile and in line with industry-leading best practice, the following streams are recommended to be implemented throughout the facility for everyday operational waste:

- Dry waste
- Food Organics
- Cardboard/paper
- Bottles & Cans (CDS) / Mixed recycling (plastics, glass, aluminium, steel)
- Landfill

In addition to the above "common" streams, the following streams are likely to be generated in a more ad-hoc manner during the ongoing operation of the facility:

- E-waste
- Battery recycling
- Toner cartridge recycling
- Polystyrene
- Equipment and lamps/globes that may contain mercury

¹ Foresight Environmental currently reports the ongoing operational waste data for over 7 million m² of Australian A and B grade commercial/retail/industrial/mixed use property. This extensive database provides the most current and detailed information on real-world waste generation performance and trends available and enables very accurate modelling for prospective property developments

4.1 Commercial Waste

The following table shows the estimated waste profile for all commercial areas based on the assumptions in Table 2.

Table 3 - Waste Generation Estimate: Commercial

Waste Stream	Kg/day	L/day	Kg/week	L/week
Dry	316	4,513	1,580	22,564
Landfill	140	1,337	702	6,686
Paper	293	3,250	1,463	16,250
Food Organics	211	752	1,053	3,761
Mixed Recycling	82	1,365	410	6,825
Cardboard	129	3,677	644	18,386
Total	1,170	14,894	5,850	74,471

4.2 Retail Waste

The following table shows the estimated waste profile for all retail areas based on the assumptions in Table 2.

Table 4 - Waste Generation Estimate: Retail

Waste Stream	Kg/day	L/day	Kg/week	L/week
Dry	27	387	190	2,710
Landfill	31	300	220	2,098
Food Organics	70	250	490	1,749
Mixed Recycling	23	376	158	2,632
Cardboard	25	709	174	4,966
Total	176	2,022	1,231	14,155

5. Waste Management Systems

The following table shows the recommended bin systems and required spatial provisions for the management of waste within 383 Kent Street, for both commercial and retail areas (combined), and the systems and collection frequency demonstrate capable capacity for the projected waste generation. Facilities management will monitor the systems and increase/adapt accordingly as occupancy increases in consultation with the appointed cleaning and waste contractors.

Table 5 - Recommended equipment and collection frequency

Waste Stream	Bin Type	Size in L	No. of bins	Weekly Clearance Frequency	Weekly capacity (L)	Estimated volume/ Week (L)	Footprint per bin m ²	Total footprint m ²
Dry	MGB	1100	5	5	27,500	25,275	1.3	6.6
Landfill	MGB	1100	2	4	8,800	8,784	1.3	2.6
*Paper	MGB	240	14	5	16,800	16,250	0.4	6.0
Food Organics	MGB	120	10	5	6,000	5,509	0.3	2.7
Mixed Recycling	MGB	660	3	5	9,900	9,457	1.0	2.9
Cardboard	MGB	1100	5	5	27,500	23,352	1.3	6.6
E-waste	MGB	240	2	1	480	Ad Hoc	0.4	0.9
Bulky storage							16.0**	16
Weigh scales							4.0	4.0
Bin wash							4.0	4.0
Total					96,980	88,626		52.3
Waste Room Total Area on Plans								76.0
Including 50% additional space for manoeuvring								78.5

*Note - paper bins typically stored on tenancy floors throughout building and only brought to waste room for collection by cleaners when full i.e., bins not stored in waste room all the time, only for collection.

**Complies with CoS Guidelines -Waste Management Areas

6. Waste Management Areas

The areas detailed in Section 5 indicate the total footprint and spatial requirements for the central waste storage area on Sussex Street Ground Level. The central waste storage area has a total area of 76m². The design delivers adequate space to house the recommended systems as shown in the figure below. As the designs are still high level, the suggested layouts and travel paths below are subject to change.

6.1 Central Waste Storage Area - B1

Figure 2: Indicative waste area layout on Sussex Street Ground Level

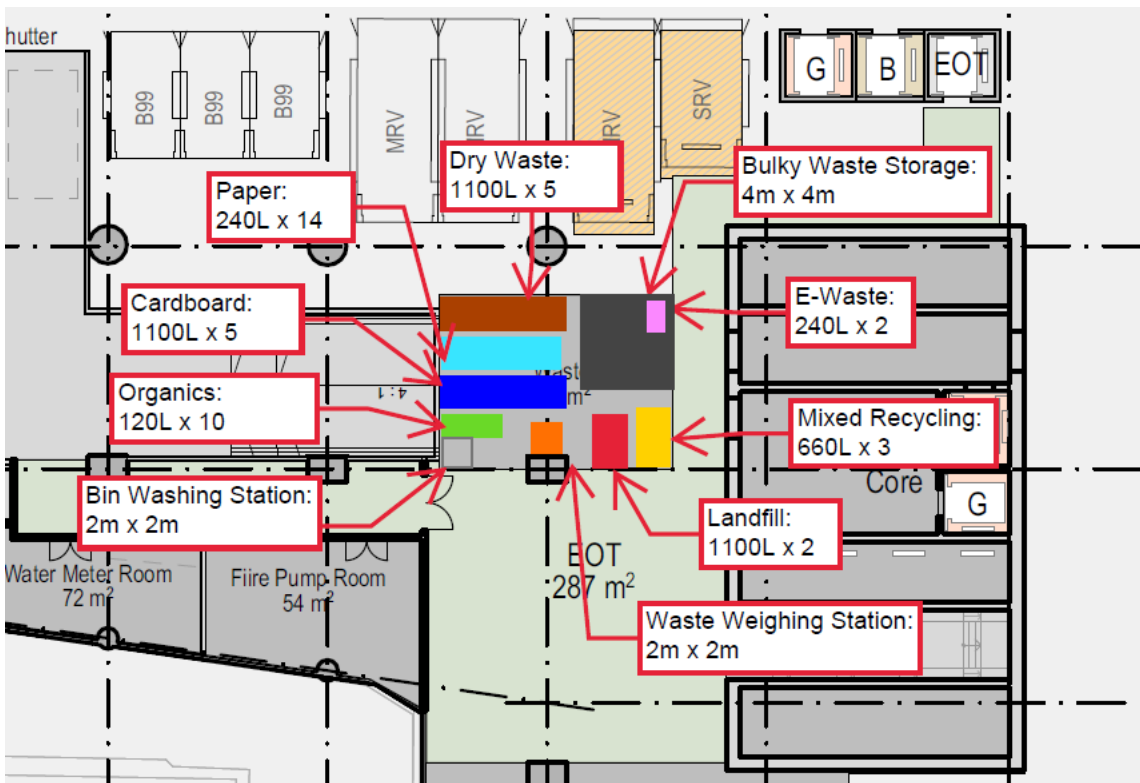

*Due to its ad hoc nature and to create space, E-waste will be housed within the Bulky Storage area.

6.2 Waste Room Amenity

The central waste and recycling storage room will have the following features:

- Ventilation: The bin storage rooms will be mechanically exhausted in accordance with AS 1668.2-2002
- Vermin and Odour Prevention:
 - Opening will be vermin proof.
 - Cleaners are to ensure that bin lids are closed when unattended.
- Doors: The room will be fitted with a close fitting self-closing door that is openable from inside the room without the use of a key. The doors will be finished with a smooth faced impervious material that is capable of being easily cleaned.
- Noise: Noise will not be an issue due to the location of the waste storage room away from public lower ground floor
- Floor: Structural concrete slab with smooth epoxy topping finish with coved wall and floor junctions. Graded drains to approved sewer connections - fitted with an in-floor dry basket arrestor approved by Sydney Water Corporation
- Walls: Brick work/concrete block or similar finished in a light coloured, washable paint
- Ceiling: Structural concrete slab over
- Lighting: Base building lighting with switches inside and outside waste room (sensors may also be used)
- Water Supply: a tap with a hose connection servicing graded bin wash areas.
- Signage: clear signage identifying the various streams and appropriate use will be prominently displayed (see section on signage below)

A full-time resource will be allocated to oversee and manage all operations within the central waste management area. The ongoing maintenance and up-keep of the waste management area will be their responsibility along with ensuring bins are stored neatly and are cleaned as required. Additionally, all waste delivered to the waste management area will be weighed/recorded over the scales and then deposited into the appropriate bin.

6.3 Signage

All waste and recycling streams should be differentiated with clear signage on all bins and on walls within the waste storage area. Below are examples of best practice appropriate signage incorporating textual information, pictures and colour-coding to communicate the message.

Figure 3: Best Practice Stream appropriate signage



7. Onsite Management Protocols

7.1 Commercial Floors

It is expected that all tenants will implement centralised bin hubs throughout their fit-out in appropriate areas. Establishing centralised bin-hubs for the management of all relevant waste streams will typically drive better staff practices - by requiring staff to interact with the centralised systems, they are forced to make a choice as to which bin they dispose their materials into, within a common area that is shared by co-workers. Additionally, the common contamination issues associated with individual desk bins or multiple bins throughout a workspace are significantly reduced through a centralised bin-hub approach.

The four primary waste streams to be implemented in each tenancy are:

1. Food Waste
2. Dry Waste
3. Bottles & Cans
4. Paper & Cardboard



Tenants can choose to implement freestanding bin hubs or conceal bins within cabinetry throughout their fit-out. Regardless of the approach, it is recommended that the 383 Kent Street tenant signage is clearly displayed throughout on bins or on cabinetry doors to ensure clear, consistent messaging is achieved throughout. The images below provide references for effective signage implementation on cabinetry.

The following figures provide examples of freestanding bin hubs with appropriate signage.

Figure 4: Recommended best practice signage displayed on cabinetry fronts



The following figures provide best practice examples of freestanding bin hubs with appropriate signage.

Figure 5: Freestanding bin hub - best practice example



Staff will be responsible for depositing their waste and recyclables into the appropriate bin throughout the day. Cleaning staff will then be responsible for emptying all materials from the bins hubs as required throughout the day into a segregated cleaner's trolley to maintain the separation of the streams before finally emptying the waste and recycling into the larger bins in the central waste storage area (or respective building interim waste storage area).

Table 6 - Primary tenant streams and management protocol

Stream	Acceptable items	Not Acceptable items	Collection Procedure
Dry Waste	All residual waste items that are not accepted in the other recycling streams. MUST be DRY - contaminated material disposed into Landfill bins	Food waste, liquid, e-waste/batteries, glass	Onsite cleaning staff to collect colour-coded bin liners from all bins as required throughout day and transfer materials to the waste management area in loading dock for weighing/recording and then disposal into the appropriate bin. See following section for detailed cleaner responsibilities.
Bottles & Cans	Empty glass, aluminium, plastic, steel bottles/cans/containers	All other items	
Paper & Cardboard	Office Paper, Envelopes, Manilla Folders, Newspapers, Magazines, Cardboard	Plastic bags, food, waxed cardboard, polystyrene, food-soiled cardboard	
Food Organics	Food Scraps, Coffee Grounds, tea bags, flowers, herbs & garden trimmings.	Plastic including straws, butter sachets, cling wrap, meat packaging. Biodegradable bags, polystyrene cups, grease trap waste, aluminium foil, coated cardboard, metal, tin, glass, paper hand towel. Australian certified compostable packaging (AS 4736) incidental to the collection of food waste, wooden or bamboo chopsticks and cutlery.	

7.2 Additional Material Streams

The following protocols would be put in place to manage additional streams.

Table 7 - Management Protocol for additional streams

Waste Stream	Management Protocol
Paper hand towel recycling	<p>In an effort to reduce waste generation volumes, a paper hand towel free system in bathrooms should be considered. Replacing hand towels with a system such as the 'Airblade' produced by Dyson² or the "Jet Towel" produced by Mitsubishi Electric³ may prove to be more environmentally (and economically) efficient than a paper hand towel system.</p> <p>If a paper hand towel system is chosen, then it should be confirmed with the appointed waste contractor which recycling stream is most appropriate for this material.</p>

² Information gathered from <http://www.dysonairblade.com.au/>

³ Information gathered from <http://www.mitsubishielectric.com/bu/handdryer/products/index.html>

Toner cartridge recycling	Where cartridges are generated recycling systems should be implemented. Typically, a free service provided by Planet Ark for example is sufficient – this system will consist of a large cardboard box located within the print rooms which will be collected by Planet Ark upon request by the facilities manager.
E-Waste	An E-waste collection service should be set up either quarterly or biannually depending on volumes generated. E-waste will be collected and managed by facilities management – all items will be transferred to the dedicated bins within the waste storage room where it will be collected directly by a specialist contractor upon request. Measures should be taken to avoid generating E-waste and take-back programs with the supplier or reuse programs with charities or schools are encouraged.

It is requested that all tenant managed streams that are implemented and managed by tenants are reported to 383 Kent Street facilities management in order to capture all relevant recycling. This will provide a complete picture of the diversion from landfill performance of each tenant and the whole asset.

7.3 Cleaner’s Process

The cleaning contractor plays an integral role in the implementation and maintenance of the best practice waste management protocols throughout all areas of 383 Kent Street – but their role is particularly important in the interface between the commercial tenant floors and the broader waste management program. The cleaners’ primary responsibilities are:

- Collection of all materials from tenant bin hubs and transfer to central waste management area
- Accurate identification and management of contamination, particularly for the Dry Waste stream – any materials deemed to be too contaminated would be disposed into Landfill bins in the waste room by cleaners.
- Weighing and recording location of all materials
- Disposal into appropriate bins for collection

7.4 Retail Back of House

Retailers are responsible for separating and managing their waste and recycling streams within their retail tenancy. The same primary waste streams used in the commercial areas are applicable to all retailers and there is an expectation that retail operators will make spatial provisions for the implementation of appropriate bin systems in their BOH areas to maximise diversion from landfill through the recommended streams.

Retail operators will be responsible for transferring their waste and recyclables to the main waste management area in the loading dock as required throughout the day. The preferred bins to be implemented in all retail tenancies are 60 or 90L multi-sort bins (retailer preference) – these bins can then be transferred to the central waste management area on a bin trolley designed for these bins. The following figure provides examples of multi-sort bins and the trolley – additional details are provided in the appendix.

Figure 6: Multi-sort bins for retail BOH areas



Figure 7: Multi-sort bin trolley example for retailer movement to waste area (reference only, not a requirement)

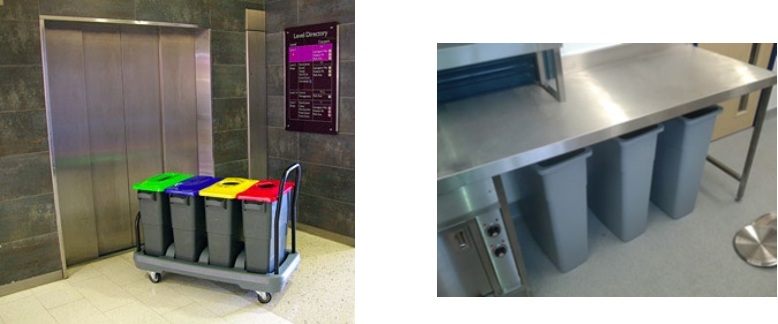

7.5 Internal Movement of Waste

The images below show the suggested waste travel pathways for retail and commercial tenants and on-site cleaners from the areas on Kent Street Ground Level, Lower Ground level, and Sussex Street Ground Level to the goods lifts that lead to the central waste storage area.

Figure 8: Suggested travel path from Goods Lifts to central waste storage room

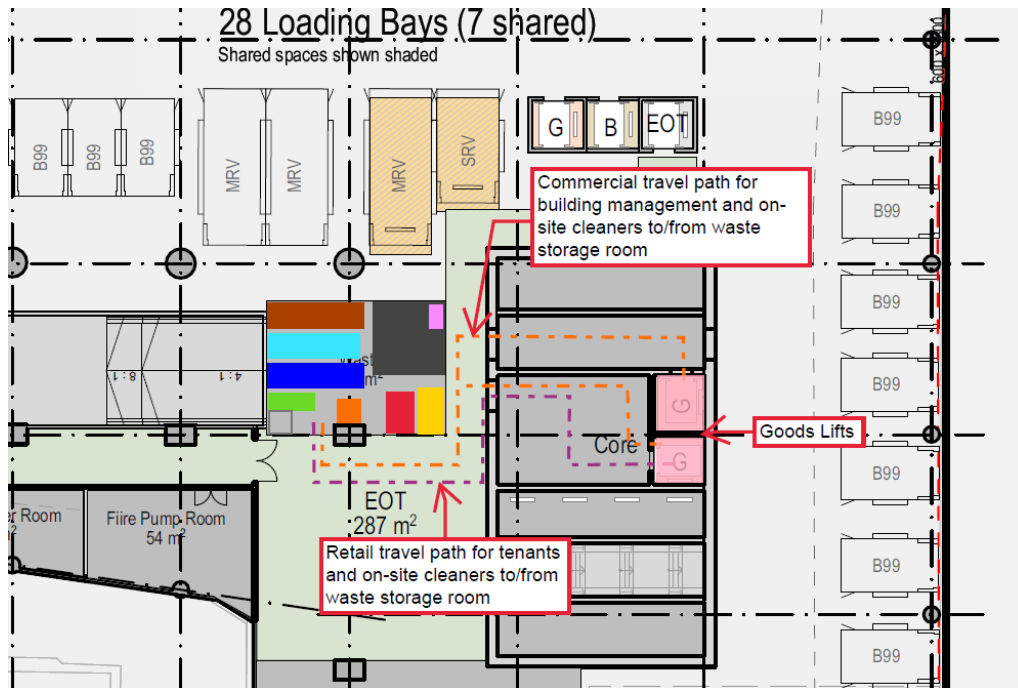

Figure 9: Kent Street Ground Level Retail waste travel path

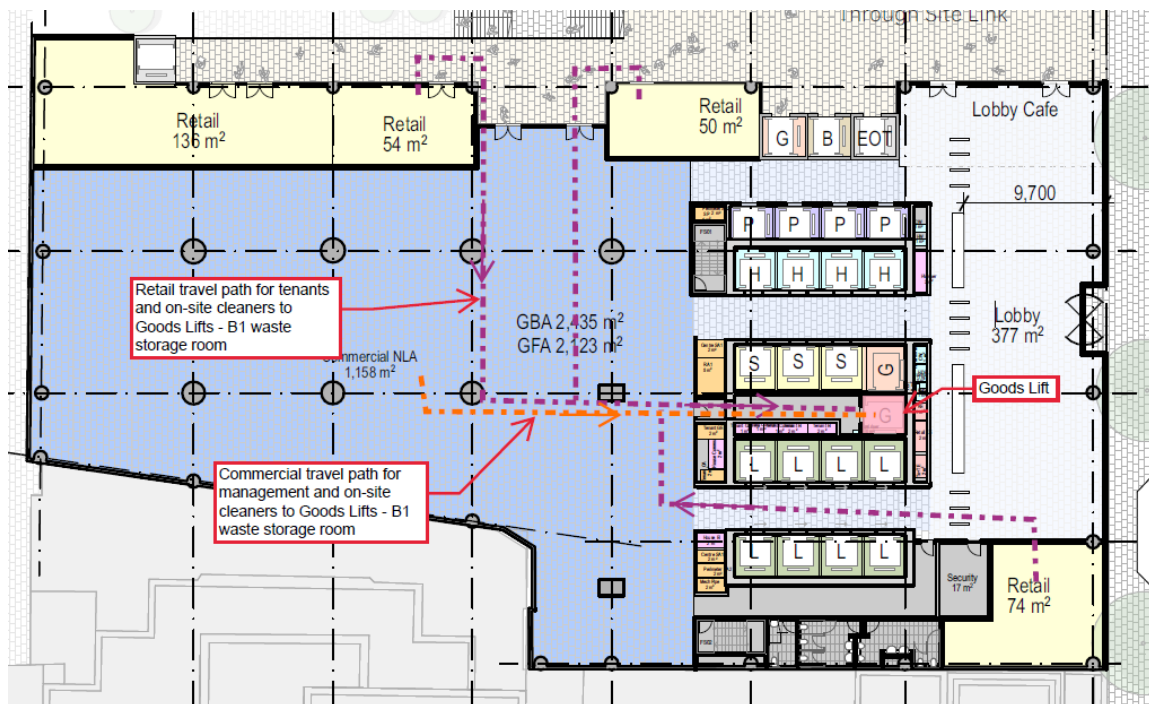

Figure 10: Lower Ground Level Retail waste travel path

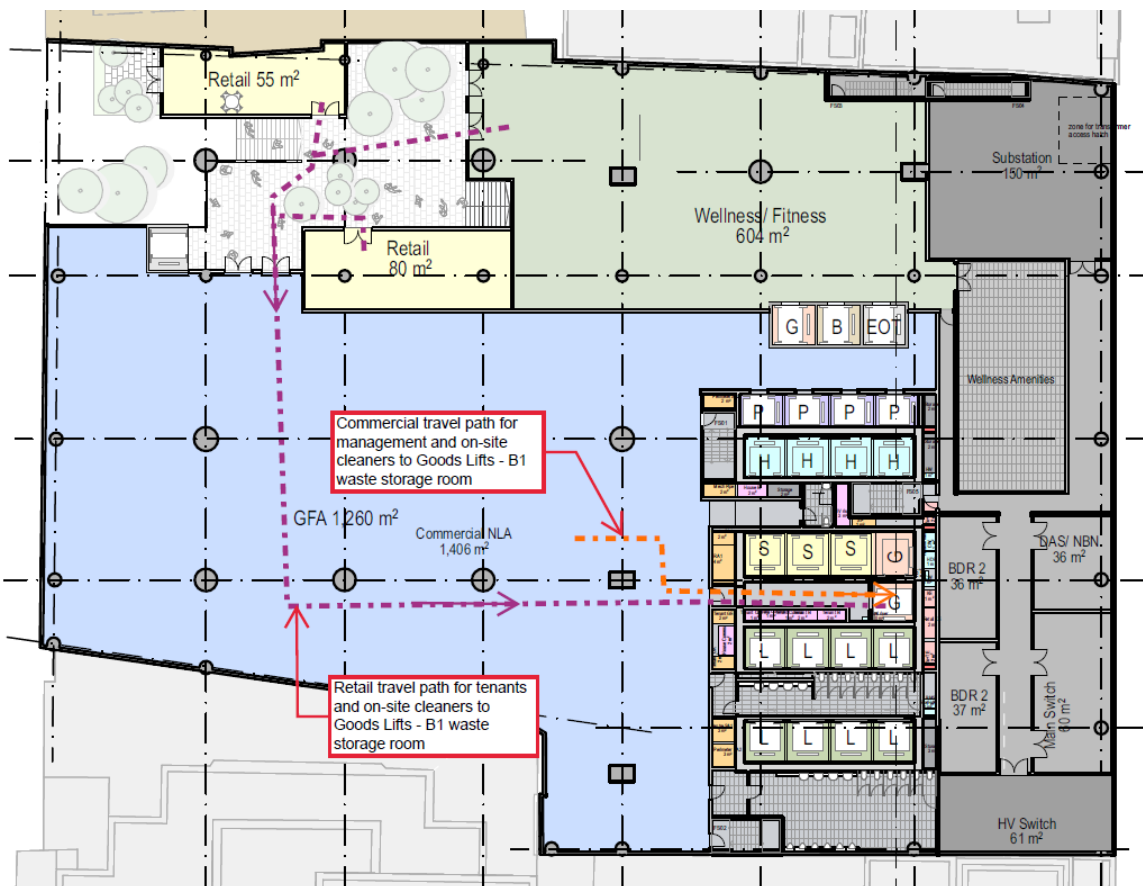
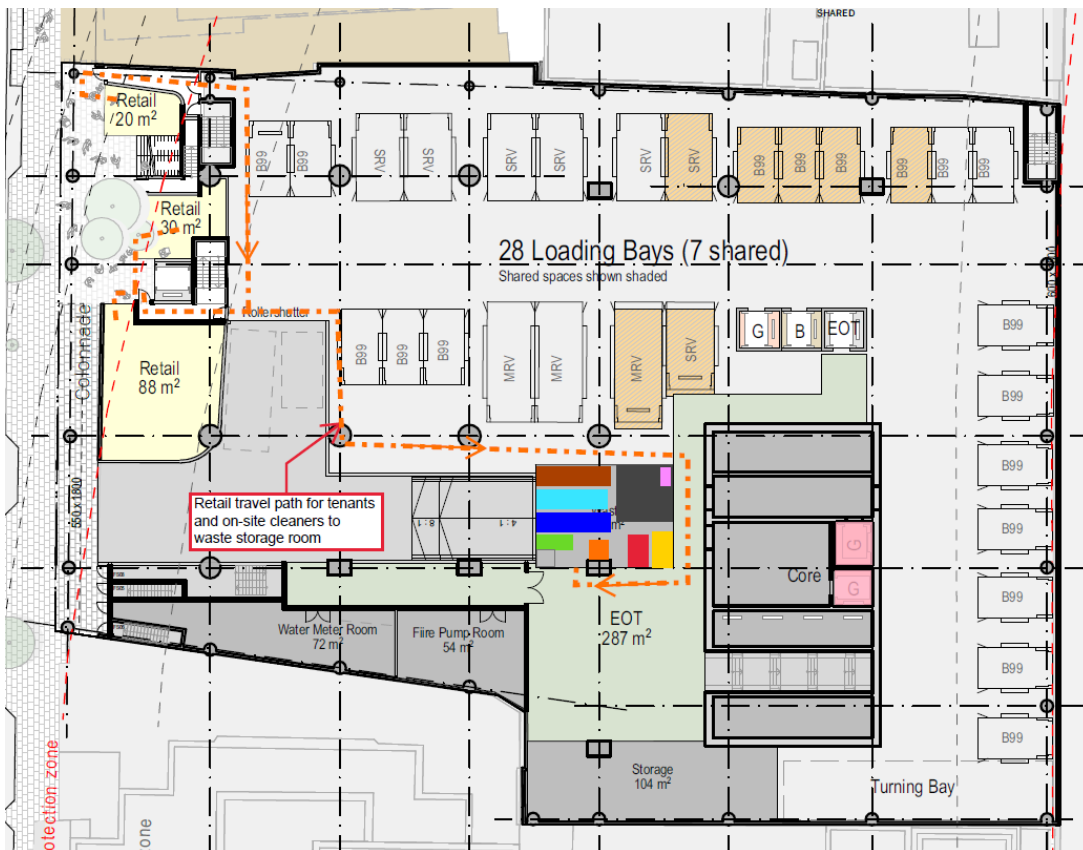

Figure 11: Sussex Street Ground Level Retail waste travel path



8. Collection

8.1 Collection Points

The appointed waste contractor will be able to access the site from the truck entry/exit point off Sussex Street shown in the figure below. All bins and/or systems for each respective stream will be collected from the MRV loading zone on the Sussex Street Level.

Figure 12: Waste contractor vehicle entry/exit and collection path

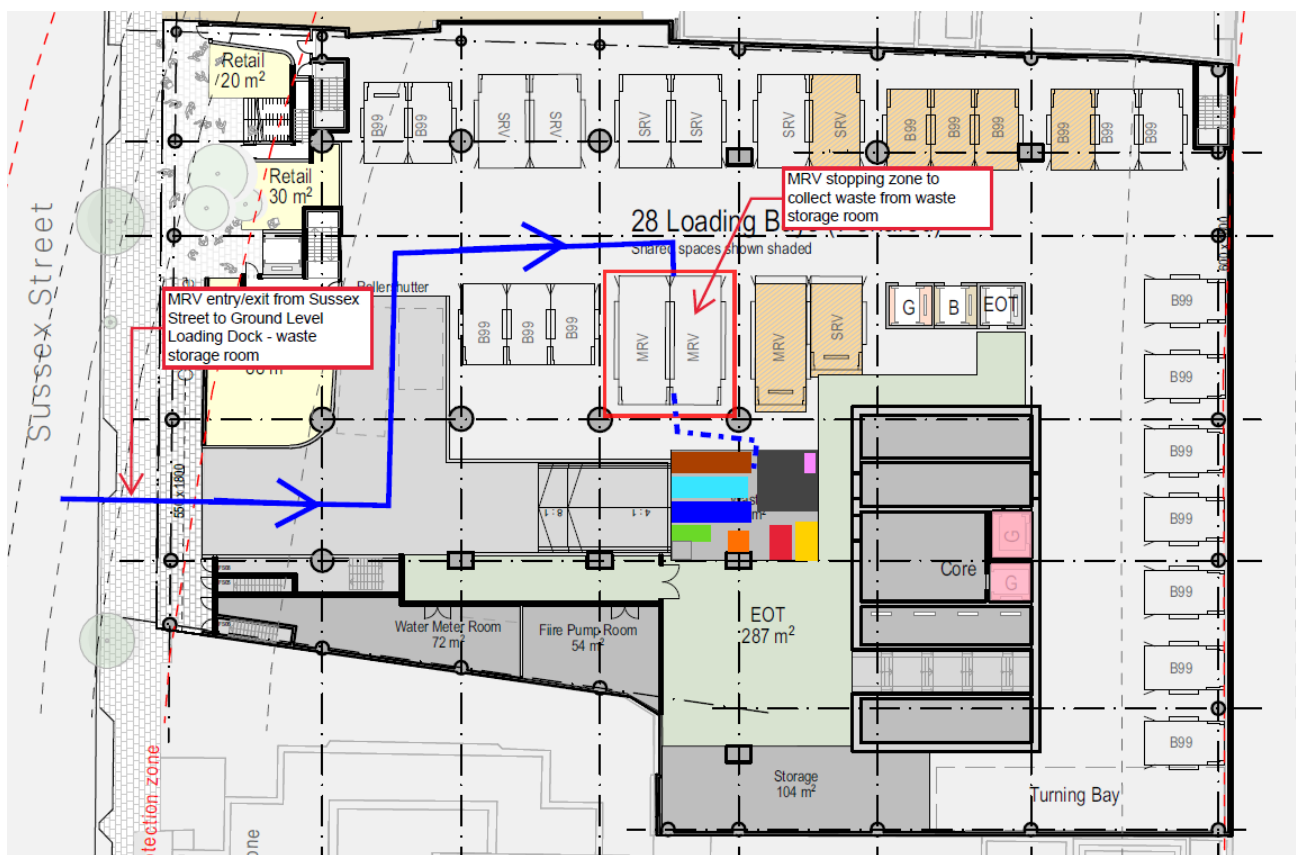

8.2 Collection Vehicles

The following figure show the indicative specifications of the collection vehicles which will be used by the appointed waste contractor to collect waste and recycling from the site.

Figure 13 Medium rigid rear-lift truck dimensions

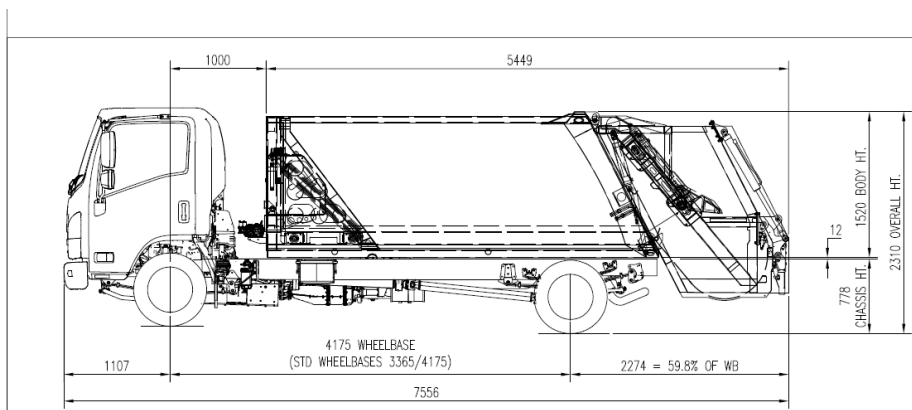

9. Reporting

383 Kent Street will implement an industry-leading reporting program, using transparent and reliable data to continually refine operational processes, inform tenant behaviours and endeavours, and monitor and report waste management performance.

Ideally, three sources of data will be used to achieve the various outcomes required at 383 Kent Street. The following table outlines the sources and their uses.

Table 8 - Data sources and reporting purposes

Data Source	Reporting purpose
Onsite scales (OSAT system)	Used to weigh all waste that enters the central waste management area. Waste is weighed according to stream, contamination, and location. This provides separation of waste performance across the different components of the development i.e. separation between buildings, commercial/retail etc. Additionally, further granularity is achieved by reporting by tenant - enabling tenant engagement and feedback to improve behaviours as well as providing tenant-specific data directly to tenants that wish to report their own performance for internal sustainability objectives.
Waste Contractor collection data	All bin collections will be reported by the waste contractor on a monthly basis. Where possible, waste contractors will weigh bins using on-truck scales - in this instance the waste contractor will report the actual weight of all materials collected. In lieu of actual weights, bin numbers will be reported, and volumes will be converted to weights using site-specific density conversions. This data provides whole-asset performance and will be used to cross reference the data from the onsite scales - although it is understood that these two sources won't necessarily match for various operational reasons - a reasonable variance is +/- 10%
Bin tally	A bin tally will be implemented and maintained by cleaners as a simple tool to count the number of bins collected by the waste contractor each night. This data source should match the collected bin numbers reported by the waste contractor. This tool provides a second source of data to cross reference against waste contractor reports and invoices and is used as an account management tool to ensure accountability in waste contractor reports/invoices.

Through the implementation of this reporting regime, 383 Kent Street will be equipped to ensure effective and transparent waste/cleaning contract account management, provide accurate feedback, education and reporting to tenants, and ensure the highest data integrity in a NABERS rating.

9.1 OSAT onsite scales

The Foresight Environmental OSAT system can be implemented within the central waste management area. The scales will be used by the onsite waste manager to weigh and record waste and recycling generation in order to satisfy the reporting requirements of 383 Kent Street. The system will be used in the following way to ensure the desired accuracy and granularity is achieved in the dataset for monitoring and performance reporting purposes:

- Onsite waste manager receives waste from different buildings and areas i.e., commercial/retail
- Bins/bags will be checked for contamination
- Bins/bags weighed, and contamination recorded and attributed to location i.e., commercial floor, or retailer etc
- Bags then disposed into appropriate bin/system

The OSAT system connects to the Foresight Environmental reporting dashboard and can also report concurrently to the 383 Kent Street BMS for real-time reporting. This system will be used by 383 Kent Street facilities management and other stakeholders including tenants for ongoing monitoring and performance reporting. Details of the Foresight Environmental OSAT system are provided in the appendix.



10. Conclusion

The details of this waste management plan confirm that the waste facilities provided in the proposed design adequately cater for the projected waste generation rates and waste management requirements of the development.

Appendix 2 - OSAT onsite scales

<https://www.osat.info/>



OSAT Features

1. INDUSTRIAL TOUCHSCREEN PC

Connectivity 3G / LTE Modem
User Interface 10" LCD touch screen panel
Storage Capacity for over 1 million transactions
Transaction time 5 sec of user interaction time per bin
Power 230V 80W Maximum

2. WEIGHING INDICATOR

Model IND236 Digital Indicator
Capability Four 3500 load cells
Trade Approval Can be calibrated for NMI approval
Power 230V 80W maximum

3. RFID SCANNER

Power Adjustable 1-30dB
Antenna 6dBi directional panel antenna
Frequency 860-960MHz
Tags UHF Gen2+

4. SITE POWER REQUIREMENTS

1x Double weather proof IP53 250V - 10amp outlet - location to be determined after preliminary site visit

5. INDUSTRIAL PLATFORM SCALES

Dimensions (mm) 1386 (w) x 1500 (d) inc.300 mm ramp (can be configured with two ramps)
Platform Height 35-45mm
Load Capacity 1500Kg
Precision 0.01Kg
Load Cells 4x500Kg IP-68 rated, hermetically sealed stainless steel

The weighing indicator, RFID scanner and the touchscreen PC are housed with the mounting plate which is mounted to the wall with 6 screw points (hardware dependent on wall - installation specifics to be confirmed at preliminary site visit)



Reporting Dashboard

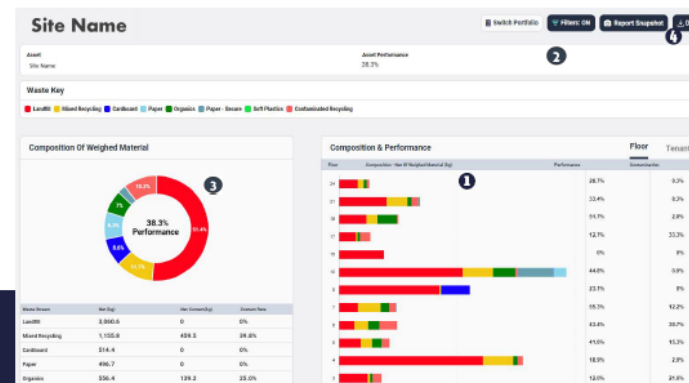

The reporting dashboard displays live visualisations of all transactional data weighed over the scale. Multiple logins can be provided for all relevant stakeholders - giving direct operational/performance insight to those that need it. The features shown above and below are only a selection of the dashboard functionality.

1. LEVEL-BY-LEVEL REPORTING

Dynamic Visuals - Composition breakdown, recycling performance and contamination.

2. FILTER BY AREA

Isolate areas, drill down for more detail.

3. PERFORMANCE SNAPSHOT

Performance at a glance, total kilograms and contamination by stream - dynamic visuals based on filter selection i.e. area/level/whole building.

4. EXPORT

Detailed data file - excel file export of raw transactional dataset.

PDF Snapshot Report - mirrors what is shown on screen, good for emailing/reporting to stakeholders.